

REVISION RECORD			
REV	ECD	DESCRIPTION	DRFT

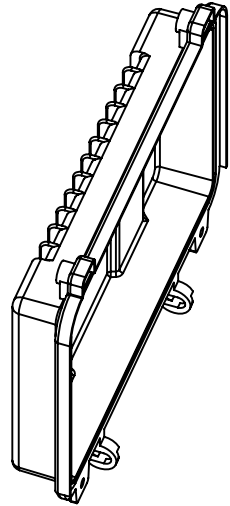

DETACHED LISTS			
 FIRST ANGLE PROJECTION	TOLERANCES EXCEPT AS NOTED MM: 0.1 ± 0.3, 0.05 ± 0.2, 0.020 ± 0.1 ANGLES ± 5°	DRFTD: DATE: DATE: DATE: CHKD: DATE: DATE: DATE: MFD: DATE: DATE: DATE: APPVL: DATE: DATE: DATE:	MATERIAL: AL QTY: 1 FINISH:
SCALE: 1:4	TITLE: APP001-S	 EVEREST WWW.EVERESTCASE.COM	DRAWING NO: APP001-S /PART NO: SIZE: A4 REV:
DD NOT SCALE DRAWING	SHEET X OF Y	DD NOT SCALE DRAWING	DD NOT SCALE DRAWING

REVISION RECORD				
REV	ECD	DESCRIPTION	DRFT	CHKD

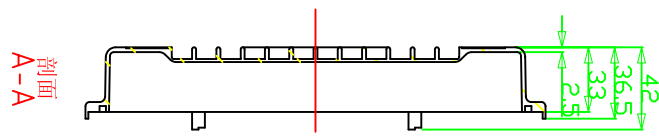
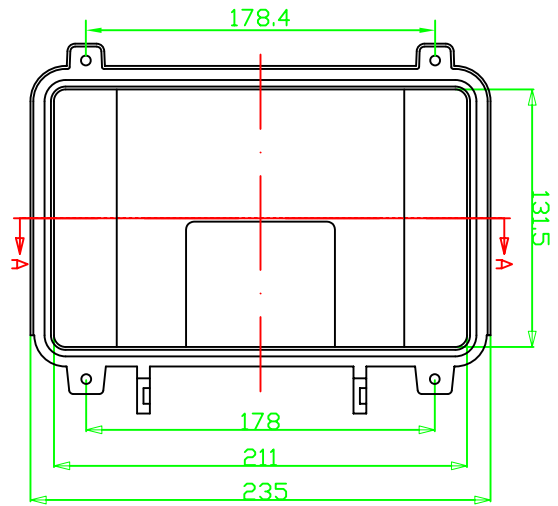
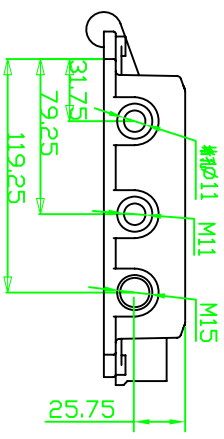
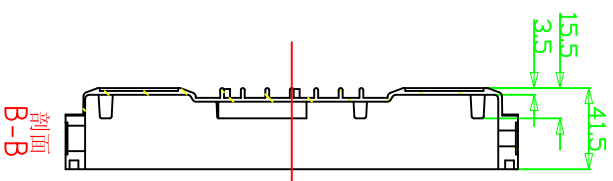
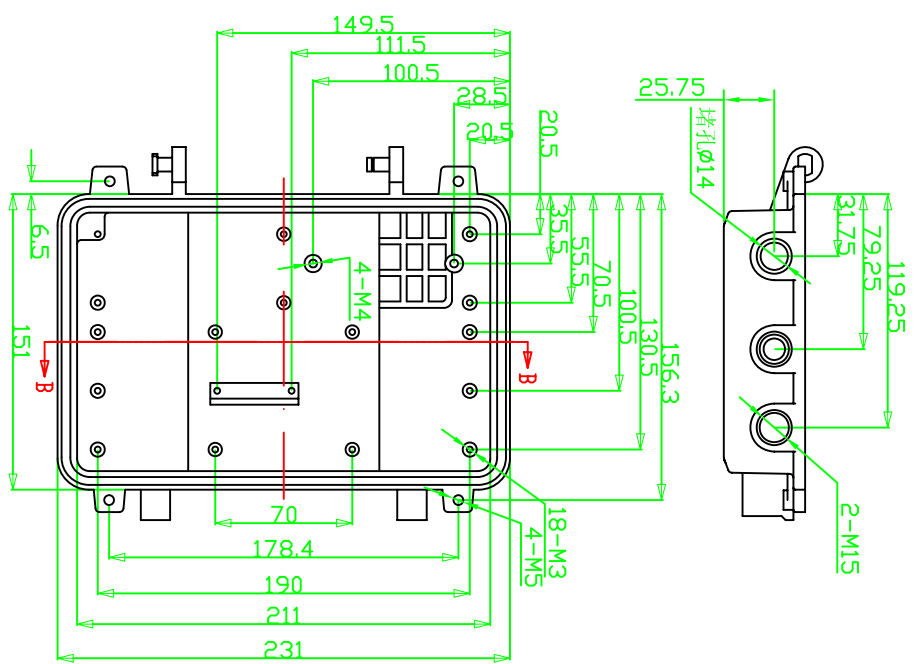
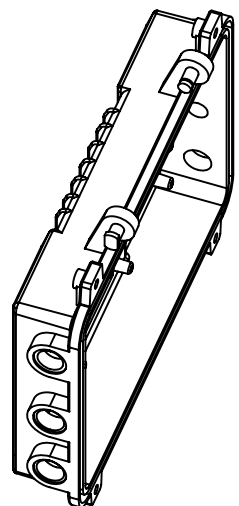

DETACHED LISTS			
 FIRST ANGLE PROJECTION	TOLERANCES EXCEPT AS NOTED MM f ± 0.3 .00 ± 0.2 0.00 ± 0.1	DRFTD CHKD MFD APPVL	DATE DATE DATE DATE
ANGLES ± 5°	MATERIAL: AL	QTY: 1	FINISH:
SCALE: 1:4	TITLE APP001-X	DRAWING NO. APP001-X	DD NOT SCALE DRAWING
SHEET X	SIZE A4	REV	OF Y

EVEREST
 WWW.EVERESTCASE.COM